



FUKUCOM COMPANY LTD.

福 靈 有 限 公 司

FLAT P, 3/F., EVEREST INDUSTRIAL CENTRE, 396 KWUN TONG ROAD,
KWUN TONG, KOWLOON, HONG KONG.

TEL: 852-2790 0314 FAX: 852-2790 0206

1SS06AWT

SCHOTTKY BARRIER DIODE

Features

- Very low forward voltage
- Very low reverse current
- Ultra small SMD package

Applications

- Ultra high-speed switching
- Voltage clamping
- Protection circuits
- Low power consumption applications

PINNING

PIN	DESCRIPTION
1	Cathode
2	Anode

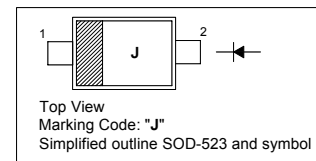

Absolute Maximum Ratings ($T_a = 25\text{ }^\circ\text{C}$)

Parameter	Symbol	Value	Unit
Reverse Voltage	V_R	40	V
Continuous Forward Current	I_F	200	mA
Repetitive Peak Forward Current $t_p \leq 1\text{ s}$	I_{FRM}	300	mA
Non-repetitive Peak Forward Current ($t = 8.3\text{ ms}$ half sinewave)	I_{FSM}	1	A
Junction Temperature	T_J	150	$^\circ\text{C}$
Storage Temperature	T_{stg}	- 65 to + 150	$^\circ\text{C}$
Operating Ambient Temperature	T_{amb}	- 65 to + 150	$^\circ\text{C}$

Characteristics at $T_a = 25\text{ }^\circ\text{C}$

Parameter	Symbol	Max.	Unit
Forward Voltage at $I_F = 0.1\text{ mA}$ at $I_F = 1\text{ mA}$ at $I_F = 10\text{ mA}$ at $I_F = 100\text{ mA}$ at $I_F = 200\text{ mA}$	V_F	220 290 360 500 600	mV
Reverse Current at $V_R = 25\text{ V}$	I_R	0.5	μA
Diode Capacitance at $V_R = 1\text{ V}$, $f = 1\text{ MHz}$	C_D	20	pF

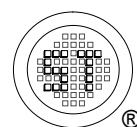

Dated : 23/11/2006



FUKUCOM COMPANY LTD.

福 靈 有 限 公 司

FLAT P, 3/F., EVEREST INDUSTRIAL CENTRE, 396 KWUN TONG ROAD,
KWUN TONG, KOWLOON, HONG KONG.

TEL: 852-2790 0314 FAX: 852-2790 0206

1SS06AWT

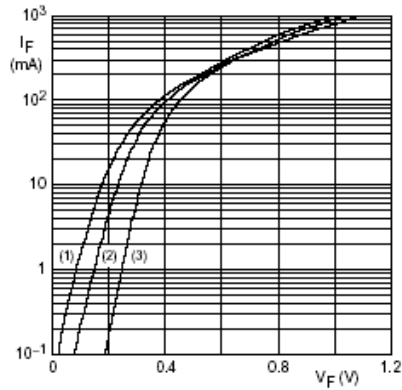

- (1) $T_{amb} = 125^{\circ}\text{C}$.
- (2) $T_{amb} = 85^{\circ}\text{C}$.
- (3) $T_{amb} = 25^{\circ}\text{C}$.

Fig. 1 Forward current as a function of forward voltage; typical values.

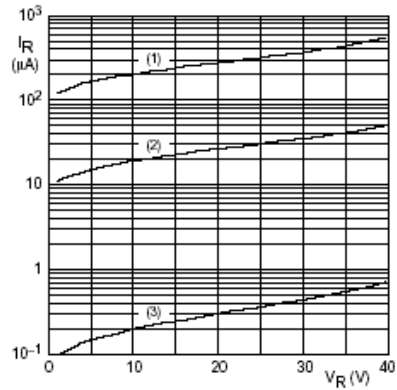

- (1) $T_{amb} = 125^{\circ}\text{C}$.
- (2) $T_{amb} = 85^{\circ}\text{C}$.
- (3) $T_{amb} = 25^{\circ}\text{C}$.

Fig. 2 Reverse current as a function of reverse voltage; typical values.

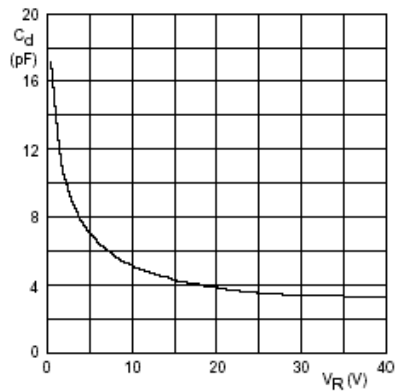

$f = 1\text{ MHz}; T_{amb} = 25^{\circ}\text{C}$.

Fig. 3 Diode capacitance as a function of reverse voltage; typical values.

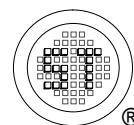

Dated : 23/11/2006



FUKUCOM COMPANY LTD.

福 靈 有 限 公 司

FLAT P, 3/F., EVEREST INDUSTRIAL CENTRE, 396 KWUN TONG ROAD,
KWUN TONG, KOWLOON, HONG KONG.

TEL: 852-2790 0314 FAX: 852-2790 0206

1SS06AWT

PACKAGE OUTLINE

Plastic surface mounted package; 2 leads

SOD-523

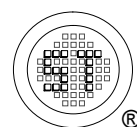
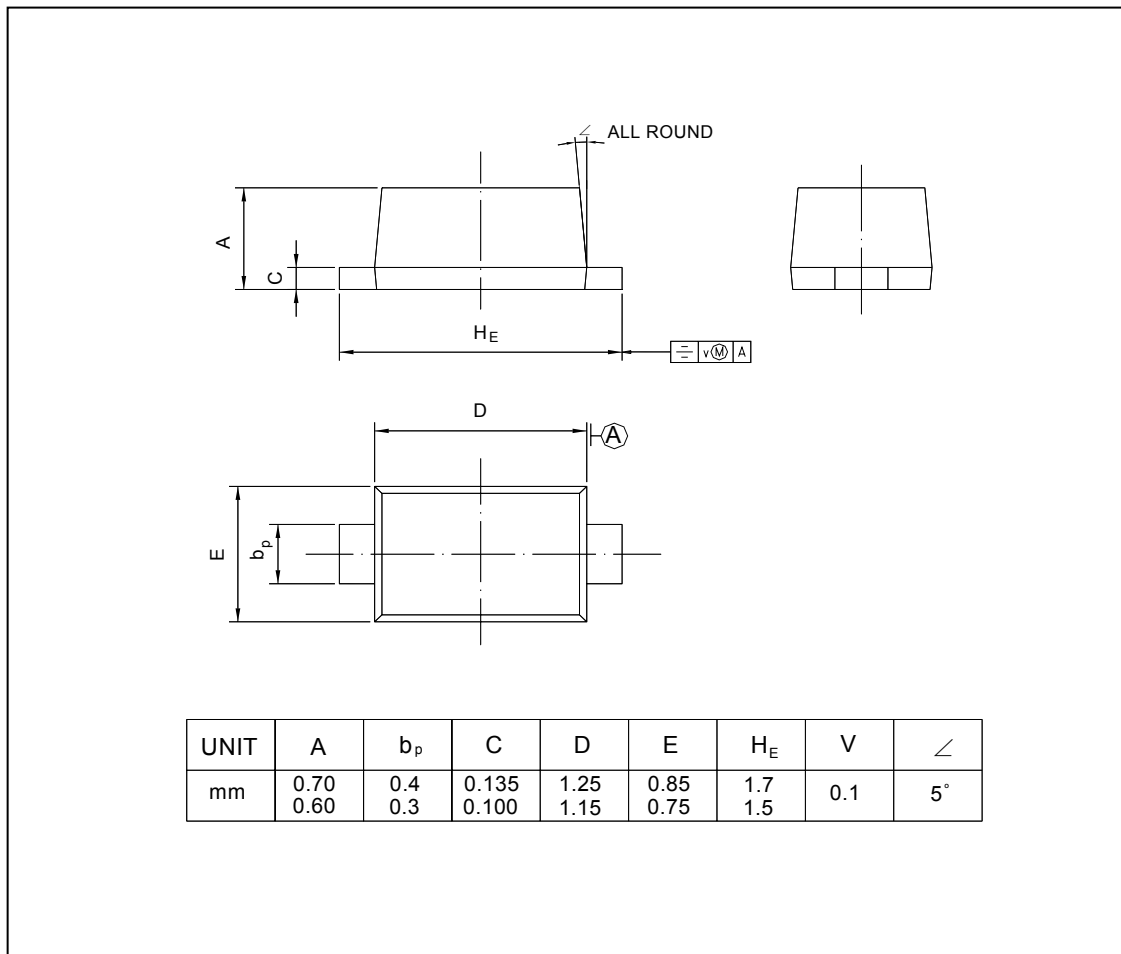

Dated : 23/11/2006