



FUKUCOM COMPANY LTD.

福 靈 有 限 公 司

FLAT P, 3/F., EVEREST INDUSTRIAL CENTRE, 396 KWUN TONG ROAD,
KWUN TONG, KOWLOON, HONG KONG.

TEL: 852-2790 0314 FAX: 852-2790 0206

1N914WT

Silicon Epitaxial Planar Switching Diode

Features

- Fast switching speed
- Ultra-small surface mount package
- For general purpose switching applications

PINNING

PIN	DESCRIPTION
1	Cathode
2	Anode

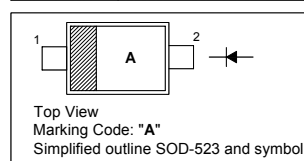

Absolute Maximum Ratings ($T_a = 25^\circ\text{C}$)

Parameter	Symbol	Value	Unit
Repetitive Reverse Voltage	V_{RRM}	100	V
Average Rectified Forward Current	$I_{F(AV)}$	200	mA
Non-repetitive Peak Forward Surge Current Pulse Width = 1 s Pulse Width = 1 μs	I_{FSM}	0.5 1	A
Power Dissipation	P_{tot}	150	mW
Thermal Resistance Junction to Ambient	$R_{\theta JA}$	833	$^\circ\text{C/W}$
Junction Temperature	T_j	150	$^\circ\text{C}$
Storage Temperature Range	T_{stg}	- 55 to + 150	$^\circ\text{C}$

Electrical Characteristics ($T_a = 25^\circ\text{C}$)

Parameter	Symbol	Min.	Max.	Unit
Breakdown Voltage at $I_R = 5 \mu\text{A}$ at $I_R = 100 \mu\text{A}$	V_R	75 100	- -	V V
Forward Voltage at $I_F = 10 \text{ mA}$	V_F	-	1	V
Reverse Current at $V_R = 20 \text{ V}$ at $V_R = 75 \text{ V}$	I_R	- -	25 5	nA μA
Diode Capacitance at $V_R = 0 \text{ V}$, $f = 1 \text{ MHz}$	C_{tot}	-	4	pF
Reverse Recovery Time at $I_{rr} = 0.1 \times I_R$, $I_F = I_R = 10 \text{ mA}$, $R_L = 100 \Omega$	t_{rr}	-	4	ns

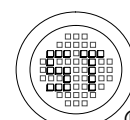

Dated : 15/06/2009



FUKUCOM COMPANY LTD.

福 靈 有 限 公 司

FLAT P, 3/F., EVEREST INDUSTRIAL CENTRE, 396 KWUN TONG ROAD,
KWUN TONG, KOWLOON, HONG KONG.

TEL: 852-2790 0314 FAX: 852-2790 0206

1N914WT

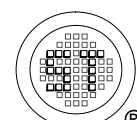
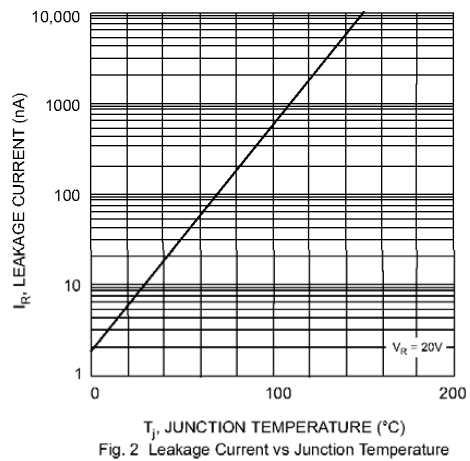
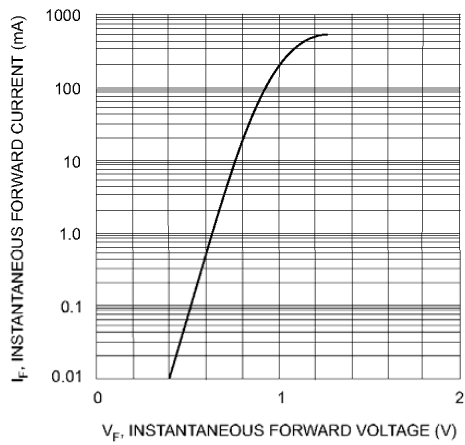

Dated : 15/06/2009



FUKUCOM COMPANY LTD.

福 靈 有 限 公 司

FLAT P, 3/F., EVEREST INDUSTRIAL CENTRE, 396 KWUN TONG ROAD,
KWUN TONG, KOWLOON, HONG KONG.

TEL: 852-2790 0314 FAX: 852-2790 0206

1N914WT

PACKAGE OUTLINE

Plastic surface mounted package; 2 leads

SOD-523

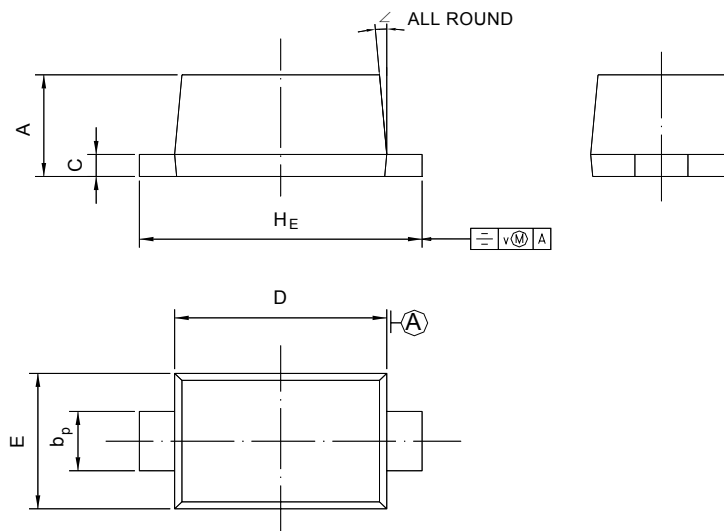

UNIT	A	b _p	C	D	E	H _E	V	∠
mm	0.70 0.60	0.4 0.3	0.135 0.100	1.25 1.15	0.85 0.75	1.7 1.5	0.1	5°

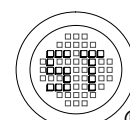

Dated : 15/06/2009