



FUKUCOM COMPANY LTD.

福 靈 有 限 公 司

FLAT P, 3/F., EVEREST INDUSTRIAL CENTRE, 396 KWUN TONG ROAD,
KWUN TONG, KOWLOON, HONG KONG.

TEL: 852-2790 0314 FAX: 852-2790 0206

MM5Z2V0~MM5Z75

SILICON PLANAR ZENER DIODES

Features

- Standard Zener Breakdown Voltage Range
2.0 V to 75 V
- Steady State Power Rating of 200 mW

PINNING

PIN	DESCRIPTION
1	Cathode
2	Anode

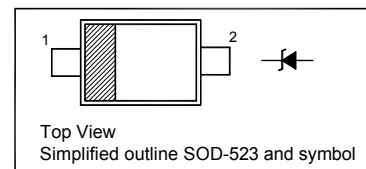

Absolute Maximum Ratings ($T_a = 25\text{ }^\circ\text{C}$)

Parameter	Symbol	Value	Unit
Total Device Dissipation	P_{tot}	200	mW
Junction and Storage Temperature Range	T_j, T_{stg}	- 65 to + 150	$^\circ\text{C}$

Characteristics at $T_a = 25\text{ }^\circ\text{C}$

Parameter	Symbol	Max.	Unit
Forward Voltage at $I_F = 10\text{ mA}$	V_F	0.9	V

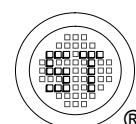

Dated : 19/04/2007



FUKUCOM COMPANY LTD.

福 靈 有 限 公 司

FLAT P, 3/F., EVEREST INDUSTRIAL CENTRE, 396 KWUN TONG ROAD,
KWUN TONG, KOWLOON, HONG KONG.

TEL: 852-2790 0314 FAX: 852-2790 0206

MM5Z2V0~MM5Z75

Type	Marking Code	Zener Voltage ¹⁾				Zener Impedance			Leakage Current	
		V _{ZT} (V)			at I _{ZT}	Z _{ZT}	Z _{ZK}	at I _{ZK}	I _R	at V _R
		Min.	Nom.	Max.	mA	Ω	Ω	mA	μA	V
MM5Z2V0	RD	1.8	2.0	2.15	5	100	-	-	120	0.5
MM5Z2V2	RE	2.08	2.2	2.33	5	100	-	-	120	0.7
MM5Z2V4	Z7	2.2	2.4	2.6	5	100	1000	1	120	1
MM5Z2V7	A8	2.5	2.7	2.9	5	100	1000	1	120	1
MM5Z3V0	B8	2.8	3.0	3.2	5	100	1000	1	50	1
MM5Z3V3	C8	3.1	3.3	3.5	5	95	1000	1	20	1
MM5Z3V6	D8	3.4	3.6	3.8	5	90	1000	1	10	1
MM5Z3V9	E8	3.7	3.9	4.1	5	90	1000	1	5	1
MM5Z4V3	F8	4	4.3	4.6	5	90	1000	1	5	1
MM5Z4V7	G8	4.4	4.7	5	5	80	800	1	2	1
MM5Z5V1	H8	4.8	5.1	5.4	5	60	500	1	2	1.5
MM5Z5V6	I8	5.2	5.6	6	5	40	200	1	1	2.5
MM5Z6V2	J8	5.8	6.2	6.6	5	10	100	1	1	3
MM5Z6V8	K8	6.4	6.8	7.2	5	15	160	1	0.5	3.5
MM5Z7V5	L8	7	7.5	7.9	5	15	160	1	0.5	4
MM5Z8V2	M8	7.7	8.2	8.7	5	15	160	1	0.5	5
MM5Z9V1	N8	8.5	9.1	9.6	5	15	160	1	0.5	6
MM5Z10	O8	9.4	10	10.6	5	20	160	1	0.1	7
MM5Z11	P8	10.4	11	11.6	5	20	160	1	0.1	8
MM5Z12	Q8	11.4	12	12.7	5	25	80	1	0.1	9
MM5Z13	R8	12.4	13.25	14.1	5	30	80	1	0.1	10
MM5Z15	S8	14.3	15	15.8	5	30	80	1	0.1	11
MM5Z16	T8	15.3	16.2	17.1	2	40	80	1	0.1	12
MM5Z18	U8	16.8	18	19.1	2	45	80	1	0.1	13
MM5Z20	V8	18.8	20	21.2	2	55	100	1	0.1	15
MM5Z22	W8	20.8	22	23.3	2	55	100	1	0.1	17
MM5Z24	X8	22.8	24.2	25.6	2	70	120	1	0.1	19
MM5Z27	Y8	25.1	27	28.9	2	80	300	1	0.1	21
MM5Z30	Z8	28	30	32	2	80	300	1	0.1	23
MM5Z33	A9	31	33	35	2	80	300	1	0.1	25
MM5Z36	B9	34	36	38	2	90	500	1	0.1	27
MM5Z39	C9	37	39	41	2	130	500	1	2	30
MM5Z43	D9	40	43	46	1	150	500	1	2	33
MM5Z47	E9	44	47	50	1	170	500	1	2	36
MM5Z51	F9	48	51	54	1	180	500	1	1	39
MM5Z56	G9	52	56	60	1	200	500	1	1	43
MM5Z62	H9	58	62	66	1	215	500	1	0.2	47
MM5Z68	I9	64	68	72	1	240	500	1	0.2	52
MM5Z75	J9	70	75	79	1	255	500	1	0.2	57

¹⁾ Tested with pulses tp = 20 ms.

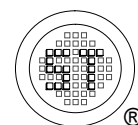

Dated : 19/04/2007



FUKUCOM COMPANY LTD.

福 靈 有 限 公 司

FLAT P, 3/F., EVEREST INDUSTRIAL CENTRE, 396 KWUN TONG ROAD,
KWUN TONG, KOWLOON, HONG KONG.

TEL: 852-2790 0314 FAX: 852-2790 0206

MM5Z2V0~MM5Z75

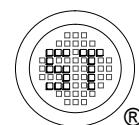
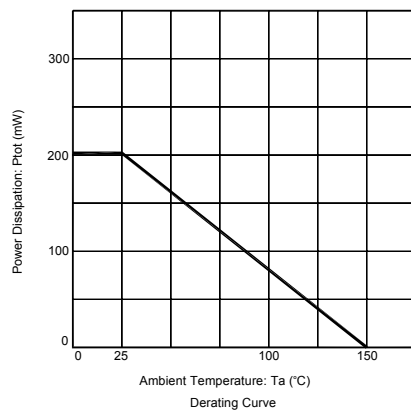

Dated : 19/04/2007



FUKUCOM COMPANY LTD.

福 靈 有 限 公 司

FLAT P, 3/F., EVEREST INDUSTRIAL CENTRE, 396 KWUN TONG ROAD,
KWUN TONG, KOWLOON, HONG KONG.

TEL: 852-2790 0314 FAX: 852-2790 0206

MM5Z2V0~MM5Z75

PACKAGE OUTLINE

Plastic surface mounted package; 2 leads

SOD-523

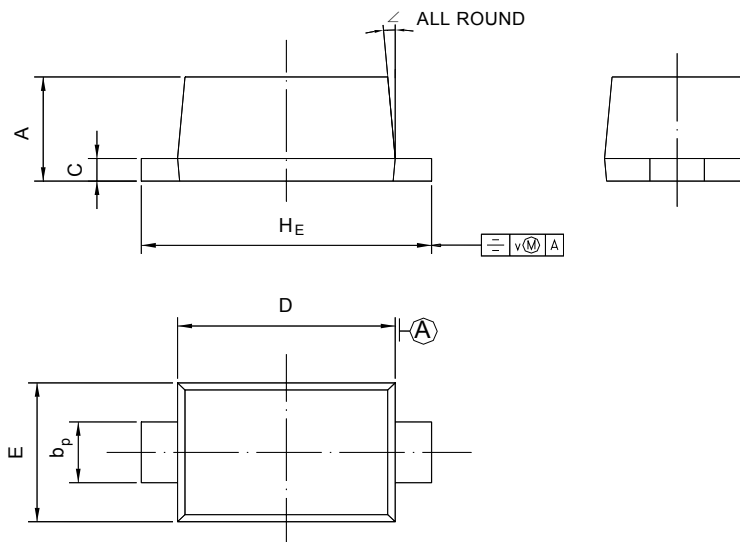

UNIT	A	b_p	C	D	E	H_E	V	\angle
mm	0.70 0.60	0.4 0.3	0.135 0.127	1.25 1.15	0.85 0.75	1.7 1.5	0.1	5°

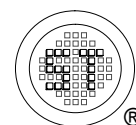

Dated : 19/04/2007