



FUKUCOM COMPANY LTD.

福 靈 有 限 公 司

FLAT P, 3/F., EVEREST INDUSTRIAL CENTRE, 396 KWUN TONG ROAD,
KWUN TONG, KOWLOON, HONG KONG.

TEL: 852-2790 0314 FAX: 852-2790 0206

BAT54W1

SCHOTTKY BARRIER DIODE

Features

- Low forward voltage

Applications

- Ultra high-speed switching
- Voltage clamping
- Protection circuits

PINNING

PIN	DESCRIPTION
1	Cathode
2	Anode

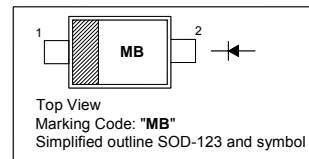

Absolute Maximum Ratings ($T_a = 25\text{ }^\circ\text{C}$)

Parameter	Symbol	Value	Unit
Reverse Voltage	V_R	30	V
Forward Current	I_F	200	mA
Repetitive Peak Forward Current	I_{FRM}	300	mA
Peak Forward Surge Current ($t_p = 10\text{ ms}$)	I_{FSM}	600	mA
Power Dissipation	P_D	230	mW
Thermal Resistance from Junction Ambient	R_{thJA}	500	K/W
Junction Temperature	T_J	125	$^\circ\text{C}$
Storage Temperature Range	T_s	- 65 to + 150	$^\circ\text{C}$

Characteristics at $T_a = 25\text{ }^\circ\text{C}$

Parameter	Symbol	Max.	Unit
Forward Voltage at $I_F = 0.1\text{ mA}$ at $I_F = 1\text{ mA}$ at $I_F = 10\text{ mA}$ at $I_F = 30\text{ mA}$ at $I_F = 100\text{ mA}$	V_F	240 320 400 500 800	mV
Reverse Current at $V_R = 25\text{ V}$	I_R	2	μA
Total Capacitance at $V_R = 1\text{ V}$, $f = 1\text{ MHz}$	C_T	10	pF
Reverse Recovery Time at $I_F = 10\text{ mA}$, $V_R = 6\text{ V}$, $I_R = 10\text{ mA}$, $R_L = 100\ \Omega$	t_{rr}	6	ns

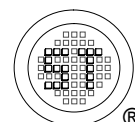

Dated : 28/03/2007



FUKUCOM COMPANY LTD.

福 靈 有 限 公 司

FLAT P, 3/F., EVEREST INDUSTRIAL CENTRE, 396 KWUN TONG ROAD,
KWUN TONG, KOWLOON, HONG KONG.

TEL: 852-2790 0314 FAX: 852-2790 0206

BAT54W1

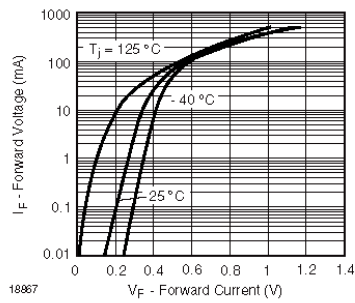

Figure 1. Typical Forward Voltage Forward Current at Various Temperatures

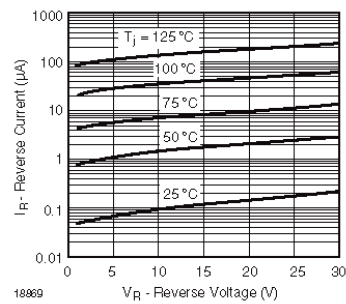

Figure 3. Typical Variation of Reverse Current at Various Temperatures

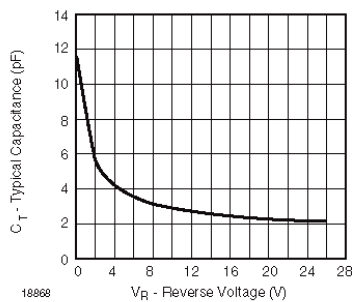
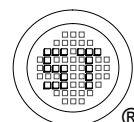

Figure 2. Typical Capacitance C_T vs. Reverse Applied Voltage V_R



Dated : 28/03/2007



FUKUCOM COMPANY LTD.

福 靈 有 限 公 司

FLAT P, 3/F., EVEREST INDUSTRIAL CENTRE, 396 KWUN TONG ROAD,
KWUN TONG, KOWLOON, HONG KONG.

TEL: 852-2790 0314 FAX: 852-2790 0206

BAT54W1

PACKAGE OUTLINE

Plastic surface mounted package; 2 leads

SOD-123

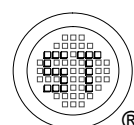
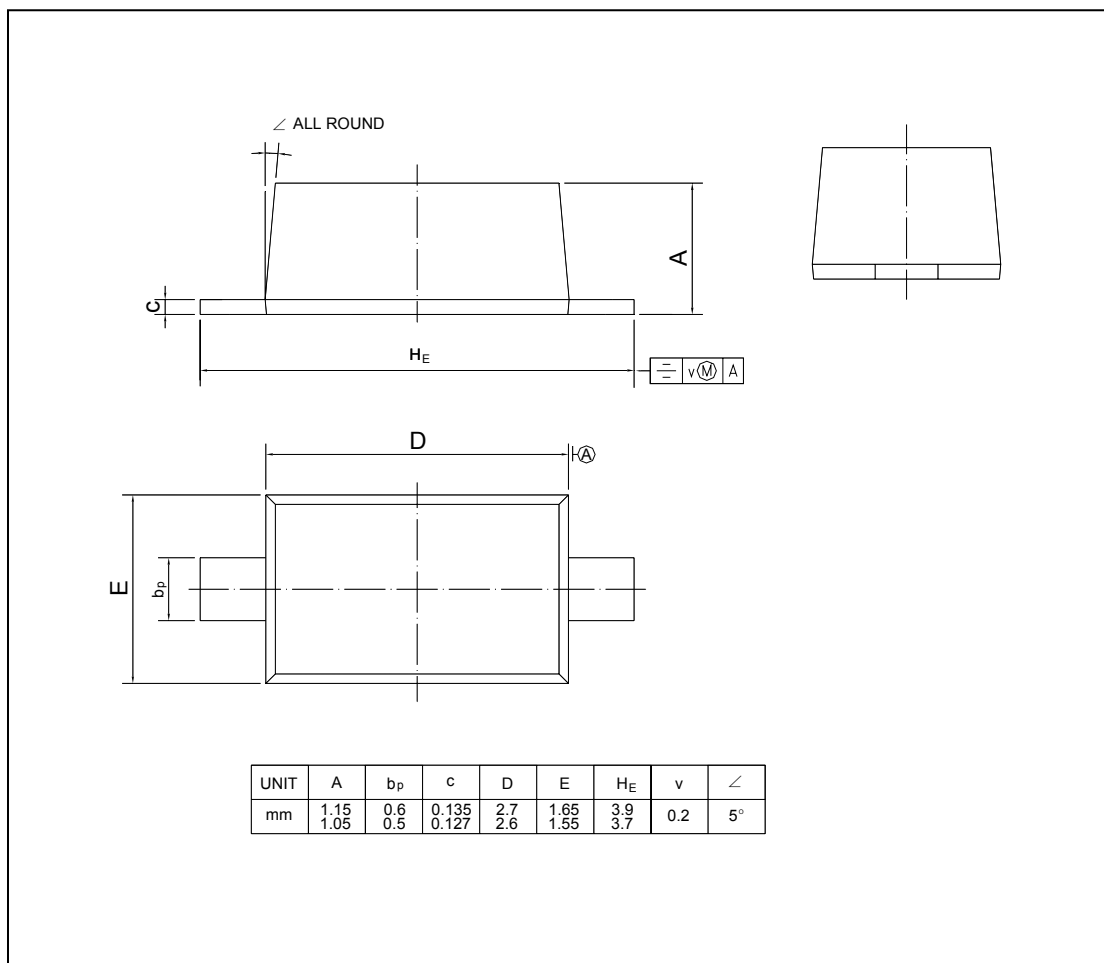

Dated : 28/03/2007