



FUKUCOM COMPANY LTD.

福 靈 有 限 公 司

FLAT P, 3/F., EVEREST INDUSTRIAL CENTRE, 396 KWUN TONG ROAD,
KWUN TONG, KOWLOON, HONG KONG.

TEL: 852-2790 0314 FAX: 852-2790 0206

BAT42W, BAT43W

SURFACE MOUNT SCHOTTKY BARRIER DIODE

Features

- Low Forward Voltage Drop
- Fast Switching

PINNING

PIN	DESCRIPTION
1	Cathode
2	Anode

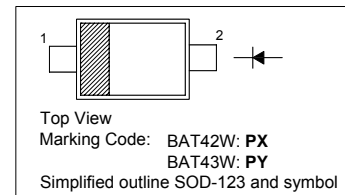

Absolute Maximum Ratings ($T_a = 25\text{ }^\circ\text{C}$)

Parameter	Symbol	Value	Unit
Repetitive Peak Reverse Voltage	V_{RRM}	30	V
Reverse Voltage	V_R	30	V
Forward Continuous Current	I_{FM}	200	mA
Repetitive Peak Forward Current at $t < 1\text{ s}$	I_{FRM}	500	mA
Non-repetitive Peak Forward Surge Current at $t < 10\text{ ms}$	I_{FSM}	2	A
Power Dissipation	P_{tot}	200	mW
Thermal Resistance Junction to Ambient	$R_{\theta JA}$	500	$^\circ\text{C/W}$
Operating and Storage Temperature Range	T_j, T_s	- 55 to + 125	$^\circ\text{C}$

Characteristics at $T_a = 25\text{ }^\circ\text{C}$

Parameter	Symbol	Min.	Max.	Unit	
Reverse Breakdown Voltage at $I_R = 100\text{ }\mu\text{A}$	$V_{(BR)R}$	30	-	V	
Reverse Current at $V_R = 25\text{ V}$	I_R	-	500	nA	
Forward Voltage at $I_F = 200\text{ mA}$	V_F	-	1	V	
at $I_F = 10\text{ mA}$		BAT42W	-	0.4	V
at $I_F = 50\text{ mA}$		BAT42W	-	0.65	V
at $I_F = 2\text{ mA}$		BAT43W	0.26	0.33	V
at $I_F = 15\text{ mA}$		BAT43W	-	0.45	V
Total Capacitance at $V_R = 1\text{ V}, f = 1\text{ MHz}$	C_T	-	10	pF	
Reverse Recovery Time at $I_F = I_R = 10\text{ mA}, I_{rr} = 0.1 \times I_R, R_L = 100\text{ }\Omega$	t_{rr}	-	5	ns	

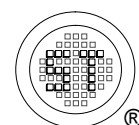

Dated : 18/04/2008



FUKUCOM COMPANY LTD.

福靈有限公司

FLAT P, 3/F., EVEREST INDUSTRIAL CENTRE, 396 KWUN TONG ROAD,
KWUN TONG, KOWLOON, HONG KONG.

TEL: 852-2790 0314 FAX: 852-2790 0206

BAT42W, BAT43W

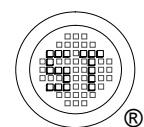
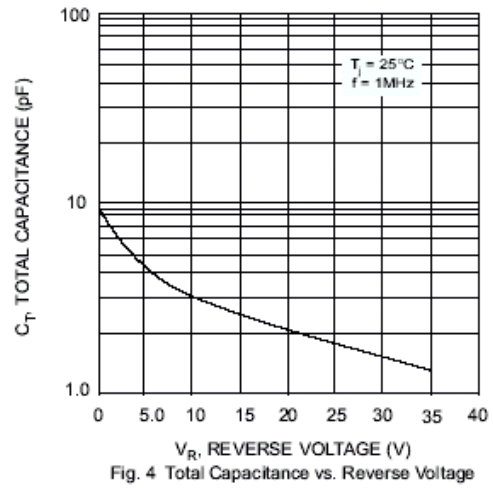
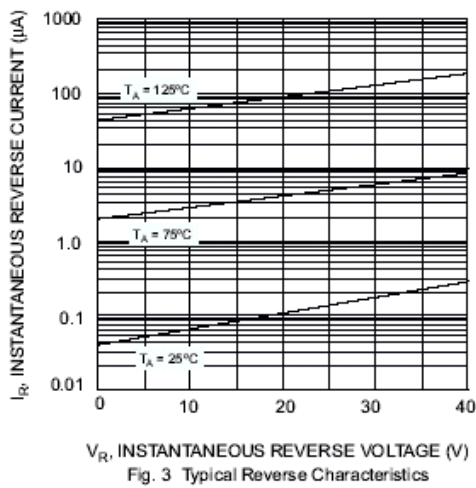
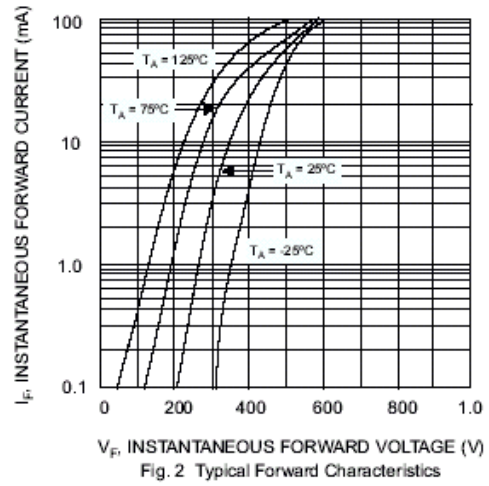
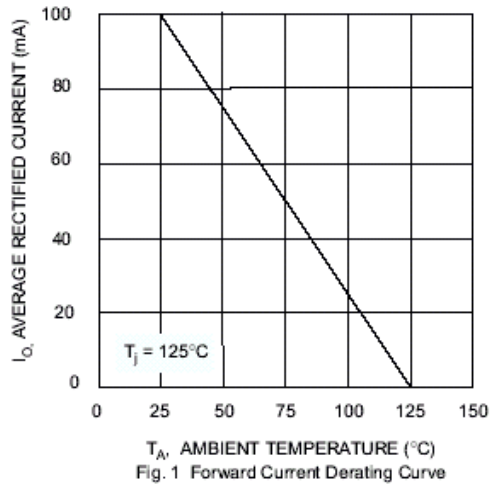

Dated : 18/04/2008



FUKUCOM COMPANY LTD.

福 靈 有 限 公 司

FLAT P, 3/F., EVEREST INDUSTRIAL CENTRE, 396 KWUN TONG ROAD,
KWUN TONG, KOWLOON, HONG KONG.

TEL: 852-2790 0314 FAX: 852-2790 0206

BAT42W, BAT43W

PACKAGE OUTLINE

Plastic surface mounted package; 2 leads

SOD-123

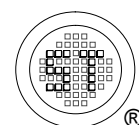
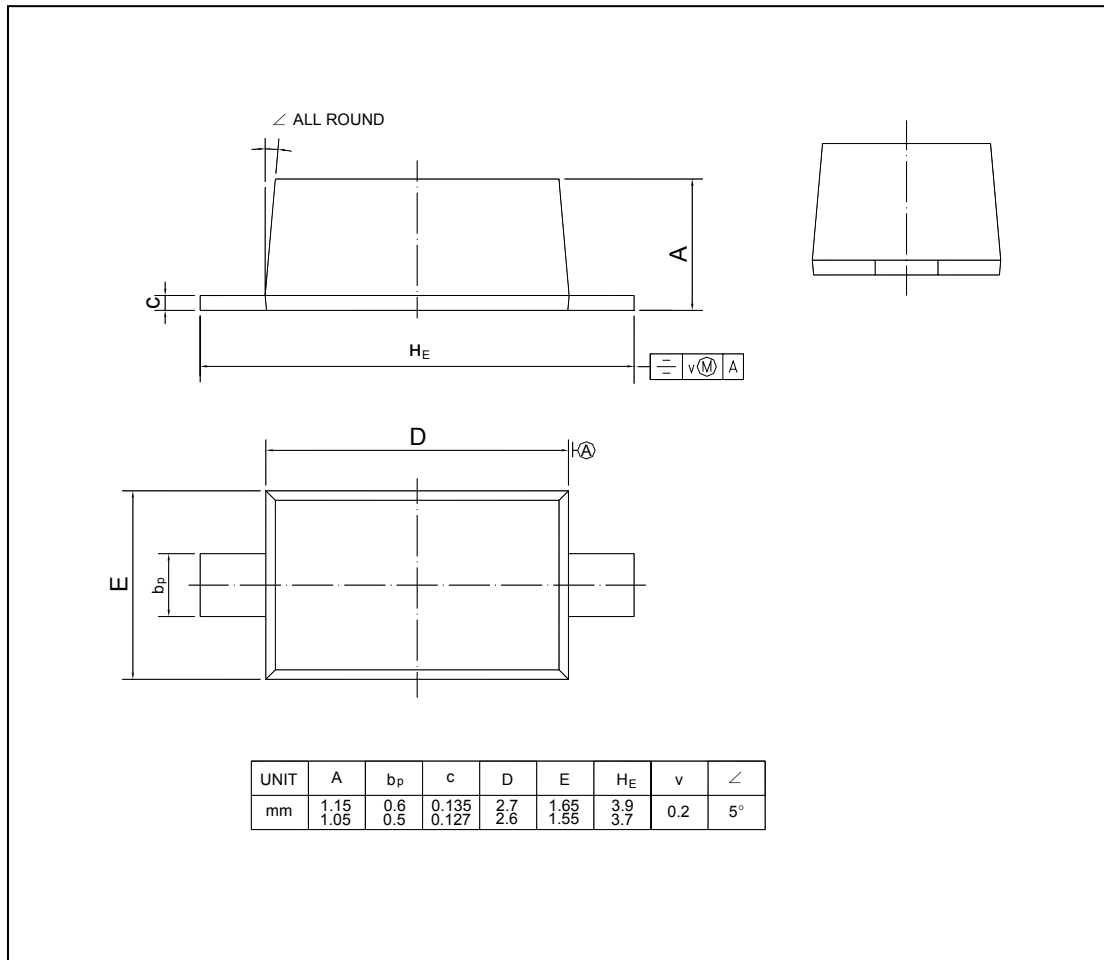

Dated : 18/04/2008