



FUKUCOM COMPANY LTD.

福 靈 有 限 公 司

FLAT P, 3/F., EVEREST INDUSTRIAL CENTRE, 396 KWUN TONG ROAD,
KWUN TONG, KOWLOON, HONG KONG.

TEL: 852-2790 0314 FAX: 852-2790 0206

MM1Z2V0~MM1Z75

SILICON PLANAR ZENER DIODES

Features

- Total power dissipation: max. 500 mW
- Small plastic package suitable for surface mounted design
- Tolerance approximately $\pm 5\%$

PINNING

PIN	DESCRIPTION
1	Cathode
2	Anode

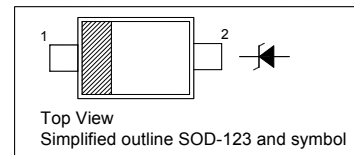

Absolute Maximum Ratings ($T_a = 25\text{ }^\circ\text{C}$)

Parameter	Symbol	Value	Unit
Power Dissipation	P_{tot}	500	mW
Junction Temperature	T_j	150	$^\circ\text{C}$
Storage Temperature Range	T_s	- 55 to + 150	$^\circ\text{C}$

Characteristics at $T_a = 25\text{ }^\circ\text{C}$

Parameter	Symbol	Max.	Unit
Thermal Resistance Junction to Ambient Air	R_{thA}	340	$^\circ\text{C}/\text{W}$
Forward Voltage at $I_F = 10\text{ mA}$	V_F	0.9	V

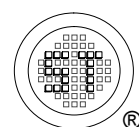

Dated : 09/11/2007



FUKUCOM COMPANY LTD.

福 靈 有 限 公 司

FLAT P, 3/F., EVEREST INDUSTRIAL CENTRE, 396 KWUN TONG ROAD,
KWUN TONG, KOWLOON, HONG KONG.

TEL: 852-2790 0314 FAX: 852-2790 0206

MM1Z2V0~MM1Z75

Characteristics at T_a = 25 °C

Type	Marking Code	Zener Voltage Range ¹⁾			Dynamic Impedance ²⁾		Reverse Leakage Current	
		V _{znom} V	I _{ZT} mA	for V _{ZT} V	Z _{ZT} (Max.) Ω	at I _Z mA	I _R (Max.) μA	at V _R V
MM1Z2V0	4A	2.0	5	1.8...2.15	100	5	120	0.5
MM1Z2V2	4B	2.2	5	2.08...2.33	100	5	120	0.7
MM1Z2V4	4C	2.4	5	2.28...2.56	100	5	120	1
MM1Z2V7	4D	2.7	5	2.5...2.9	110	5	120	1
MM1Z3V0	4E	3.0	5	2.8...3.2	120	5	50	1
MM1Z3V3	4F	3.3	5	3.1...3.5	130	5	20	1
MM1Z3V6	4H	3.6	5	3.4...3.8	130	5	10	1
MM1Z3V9	4J	3.9	5	3.7...4.1	130	5	5	1
MM1Z4V3	4K	4.3	5	4...4.6	130	5	5	1
MM1Z4V7	4M	4.7	5	4.4...5	130	5	2	1
MM1Z5V1	4N	5.1	5	4.8...5.4	130	5	2	1.5
MM1Z5V6	4P	5.6	5	5.2...6	80	5	1	2.5
MM1Z6V2	4R	6.2	5	5.8...6.6	50	5	1	3
MM1Z6V8	4X	6.8	5	6.4...7.2	30	5	0.5	3.5
MM1Z7V5	4Y	7.5	5	7...7.9	30	5	0.5	4
MM1Z8V2	4Z	8.2	5	7.7...8.7	30	5	0.5	5
MM1Z9V1	5A	9.1	5	8.5...9.6	30	5	0.5	6
MM1Z10	5B	10	5	9.4...10.6	30	5	0.1	7
MM1Z11	5C	11	5	10.4...11.6	30	5	0.1	8
MM1Z12	5D	12	5	11.4...12.7	35	5	0.1	9
MM1Z13	5E	13	5	12.4...14.1	35	5	0.1	10
MM1Z15	5F	15	5	13.8...15.6	40	5	0.1	11
MM1Z16	5H	16	5	15.3...17.1	40	5	0.1	12
MM1Z18	5J	18	5	16.8...19.1	45	5	0.1	13
MM1Z20	5K	20	5	18.8...21.2	50	5	0.1	15
MM1Z22	5M	22	5	20.8...23.3	55	5	0.1	17
MM1Z24	5N	24	5	22.8...25.6	60	5	0.1	19
MM1Z27	5P	27	5	25.1...28.9	70	2	0.1	21
MM1Z30	5R	30	5	28...32	80	2	0.1	23
MM1Z33	5X	33	5	31...35	80	2	0.1	25
MM1Z36	5Y	36	5	34...38	90	2	0.1	27
MM1Z39	5Z	39	2.5	37...41	100	2	2	30
MM1Z43	6A	43	2.5	40...46	130	2	2	33
MM1Z47	6B	47	2.5	44...50	150	2	2	36
MM1Z51	6C	51	2.5	48...54	180	2	1	39
MM1Z56	6D	56	2.5	52...60	180	2	1	43
MM1Z62	6E	62	2.5	58...66	200	2	0.2	47
MM1Z68	6F	68	2.5	64...72	250	2	0.2	52
MM1Z75	6H	75	2.5	70...79	300	2	0.2	57

¹⁾ V_Z is tested with pulses (20 ms).

²⁾ Z_{ZT} is measured at I_Z by given a very small A.C. current signal.

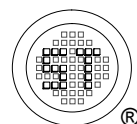

Dated : 09/11/2007



FUKUCOM COMPANY LTD.

福 靈 有 限 公 司

FLAT P, 3/F., EVEREST INDUSTRIAL CENTRE, 396 KWUN TONG ROAD,
KWUN TONG, KOWLOON, HONG KONG.

TEL: 852-2790 0314 FAX: 852-2790 0206

MM1Z2V0~MM1Z75

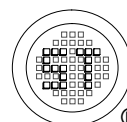
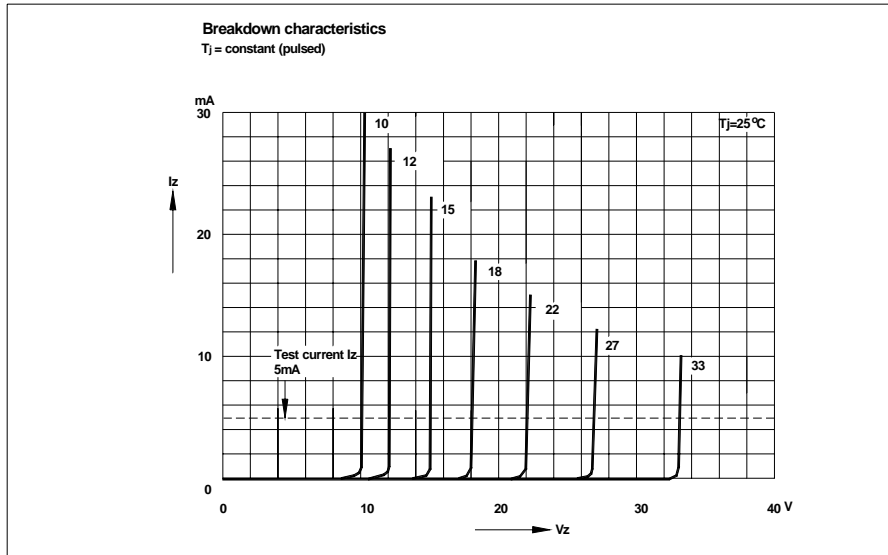
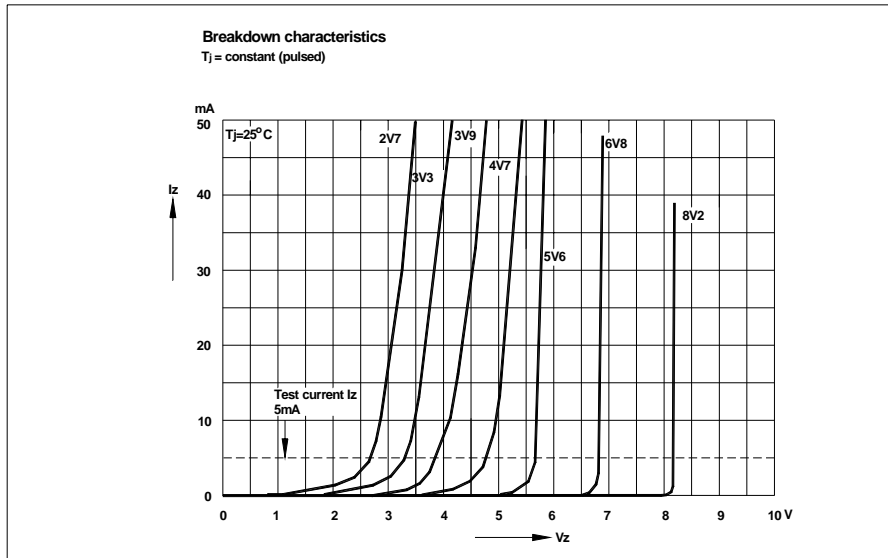

Dated : 09/11/2007



FUKUCOR COMPANY LTD.

福 靈 有 限 公 司

FLAT P, 3/F., EVEREST INDUSTRIAL CENTRE, 396 KWUN TONG ROAD,
KWUN TONG, KOWLOON, HONG KONG.

TEL: 852-2790 0314 FAX: 852-2790 0206

MM1Z2V0~MM1Z75

PACKAGE OUTLINE

Plastic surface mounted package; 2 leads

SOD-123

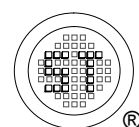
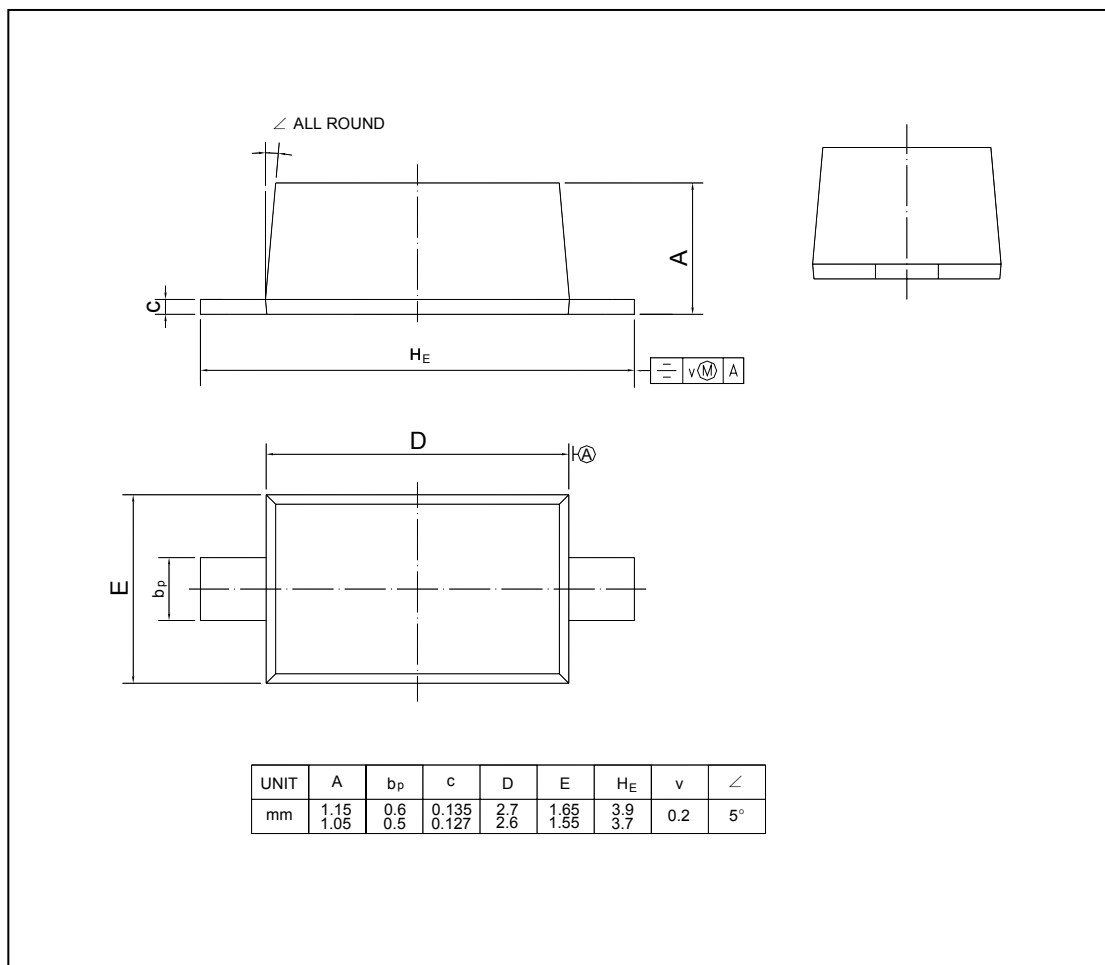

Dated : 09/11/2007