



FUKUCOM COMPANY LTD.

福靈有限公司

FLAT P, 3/F., EVEREST INDUSTRIAL CENTRE, 396 KWUN TONG ROAD,
KWUN TONG, KOWLOON, HONG KONG.

TEL: 852-2790 0314 FAX: 852-2790 0206

1SS400

SILICON EPITAXIAL PLANAR SWITCHING DIODE

for high speed switching application

Features

- Extremely small surface mounting type
- High reliability

PINNING

PIN	DESCRIPTION
1	Cathode
2	Anode

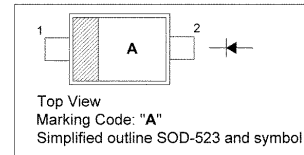

Absolute Maximum Ratings ($T_a = 25\text{ }^\circ\text{C}$)

Parameter	Symbol	Value	Unit
Peak Reverse Voltage	V_{RM}	90	V
Reverse Voltage	V_R	80	V
Peak Forward Current	I_{FM}	225	mA
Average Rectified Forward Current	I_O	100	mA
Surge Current (1 s)	I_{FSM}	500	mA
Junction Temperature	T_J	125	$^\circ\text{C}$
Storage Temperature	T_s	- 55 to + 125	$^\circ\text{C}$

Characteristics at $T_a = 25\text{ }^\circ\text{C}$

Parameter	Symbol	Max.	Unit
Forward Voltage at $I_F = 100\text{ mA}$	V_F	1.2	V
Reverse Current at $V_R = 80\text{ V}$	I_R	0.1	μA
Capacitance Between Terminals at $V_R = 0.5\text{ V}$, $f = 1\text{ MHz}$	C_T	3	pF
Reverse Recovery Time at $V_R = 6\text{ V}$, $I_F = 10\text{ mA}$, $R_L = 100\ \Omega$	t_{rr}	4	ns

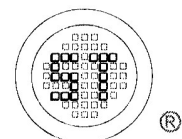

SEMTECH

Dated : 23/11/2006



FUKUCOM COMPANY LTD.

福靈有限公司

FLAT P, 3/F., EVEREST INDUSTRIAL CENTRE, 396 KWUN TONG ROAD,
KWUN TONG, KOWLOON, HONG KONG.

TEL: 852-2790 0314 FAX: 852-2790 0206

1SS400

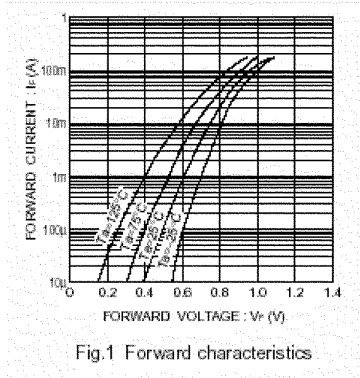

Fig.1 Forward characteristics

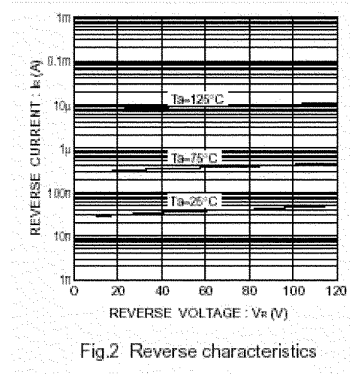

Fig.2 Reverse characteristics

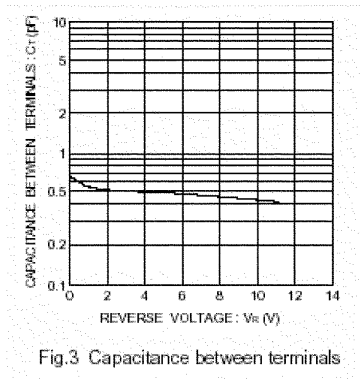

Fig.3 Capacitance between terminals

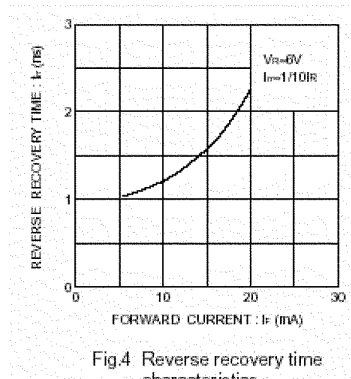

Fig.4 Reverse recovery time characteristics

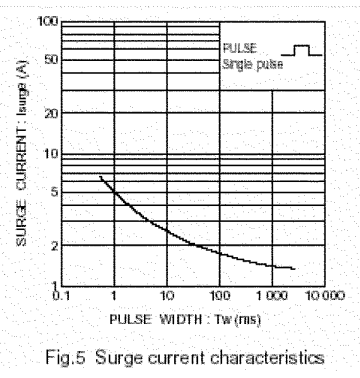

Fig.5 Surge current characteristics

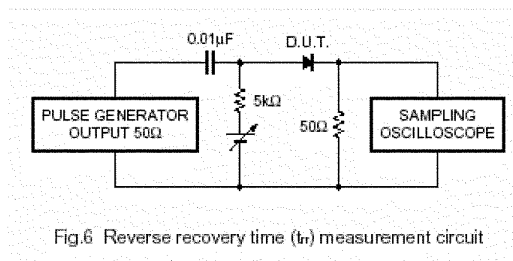
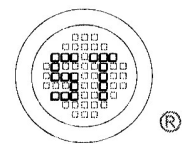

Fig.6 Reverse recovery time (t_R) measurement circuit



SEMTECH

Dated : 23/11/2006



FUKUCOM COMPANY LTD.

福靈有限公司

FLAT P, 3/F., EVEREST INDUSTRIAL CENTRE, 396 KWUN TONG ROAD,
KWUN TONG, KOWLOON, HONG KONG.

TEL: 852-2790 0314 FAX: 852-2790 0206

1SS400

PACKAGE OUTLINE

Plastic surface mounted package; 2 leads

SOD-523

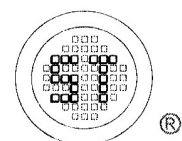
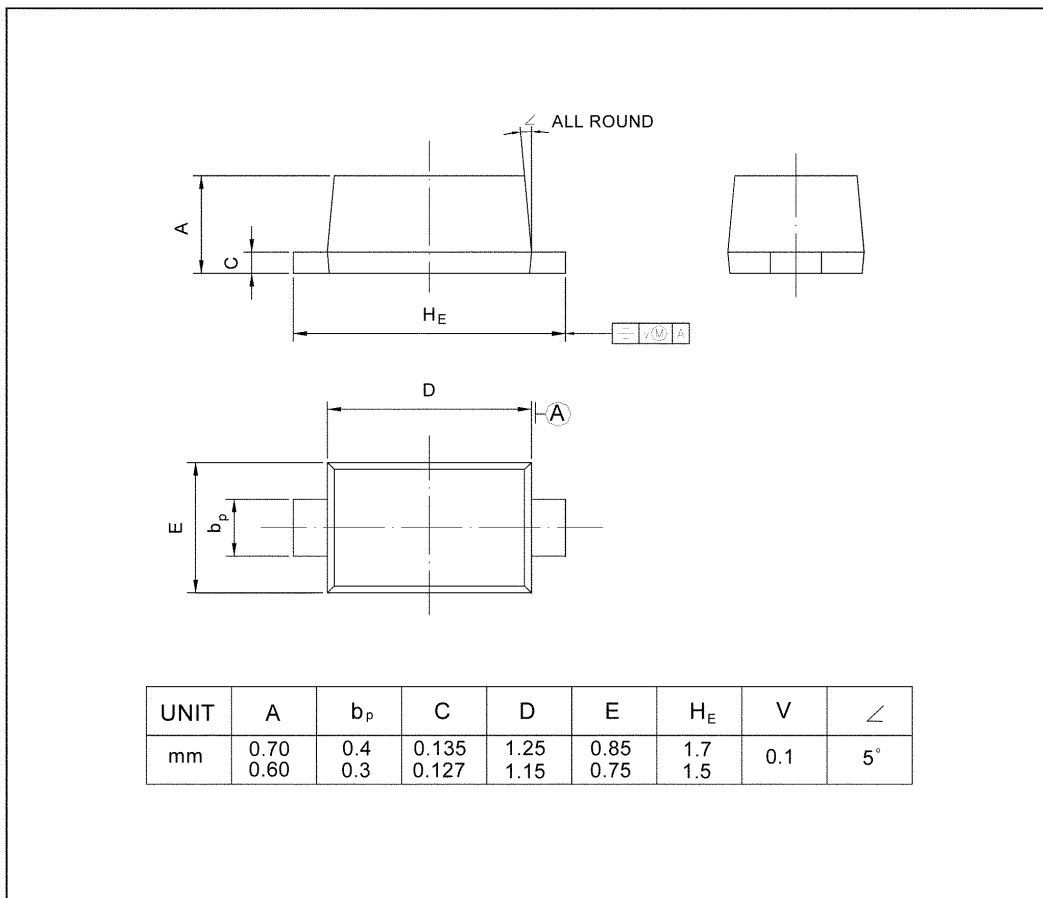

SEMTECH

Dated : 23/11/2006