



FUKUCOM COMPANY LTD.

福 靈 有 限 公 司

FLAT P, 3/F., EVEREST INDUSTRIAL CENTRE, 396 KWUN TONG ROAD,
KWUN TONG, KOWLOON, HONG KONG.

TEL: 852-2790 0314 FAX: 852-2790 0206

MBR0540

SCHOTTKY BARRIER RECTIFIERS

Features

- Low forward voltage drop
- High conductance

PINNING

PIN	DESCRIPTION
1	Cathode
2	Anode

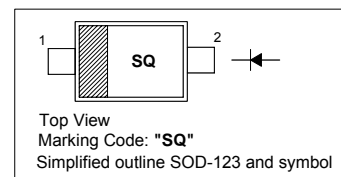

Absolute Maximum Ratings ($T_a = 25\text{ }^\circ\text{C}$)

Parameter	Symbol	Value	Unit
Peak Repetitive Reverse Voltage	V_{RRM}	40	V
Reverse Voltage	V_R	40	V
Average Rectified Forward Current	$I_{F(AV)}$	500	mA
Non-Repetitive Peak Forward Surge Current (Half Wave, Single Phase, 60 Hz)	I_{FSM}	5.5	A
Thermal Resistance Junction to Lead ¹⁾	$R_{\theta JL}$	118	$^\circ\text{C/W}$
Thermal Resistance Junction to Ambient ²⁾	$R_{\theta JA}$	206	$^\circ\text{C/W}$
Operating Junction Temperature Range	T_J	- 65 to + 125	$^\circ\text{C}$
Storage Temperature Range	T_{stg}	- 65 to + 150	$^\circ\text{C}$

¹⁾ Device mounted on FR-4 PCB 0.013 mm.

²⁾ 1 inch" pad size (1 X 0.5 inch for each lead) on FR4 board.

Characteristics at $T_a = 25\text{ }^\circ\text{C}$

Parameter	Symbol	Max.	Unit
Forward Voltage at $I_F = 0.5\text{ A}$ at $I_F = 1\text{ A}$ at $I_F = 0.5\text{ A}, T_a = 100\text{ }^\circ\text{C}$ at $I_F = 1\text{ A}, T_a = 100\text{ }^\circ\text{C}$	V_F	0.51 0.62 0.46 0.61	V
Reverse Leakage Current at $V_R = 20\text{ V}$ at $V_R = 40\text{ V}$ at $V_R = 20\text{ V}, T_a = 100\text{ }^\circ\text{C}$ at $V_R = 40\text{ V}, T_a = 100\text{ }^\circ\text{C}$	I_R	10 20 5 13	μA μA mA mA

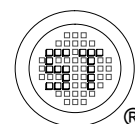



FUKUCOM COMPANY LTD.

福 靈 有 限 公 司

FLAT P, 3/F., EVEREST INDUSTRIAL CENTRE, 396 KWUN TONG ROAD,
KWUN TONG, KOWLOON, HONG KONG.

TEL: 852-2790 0314 FAX: 852-2790 0206

MBR0540

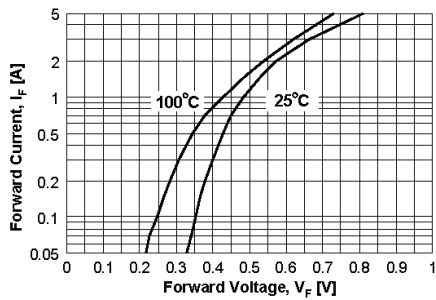

Figure 1. Forward Voltage Characteristics

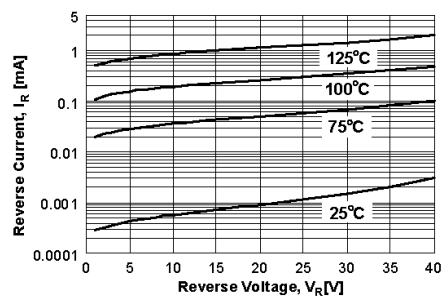

Figure 2. Reverse Current vs Reverse Voltage

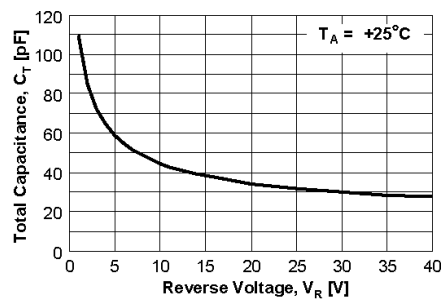
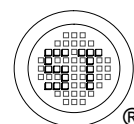

Figure 3. Total Capacitance





FUKUCOM COMPANY LTD.

福 靈 有 限 公 司

FLAT P, 3/F., EVEREST INDUSTRIAL CENTRE, 396 KWUN TONG ROAD,
KWUN TONG, KOWLOON, HONG KONG.

TEL: 852-2790 0314 FAX: 852-2790 0206

MBR0540

PACKAGE OUTLINE

Plastic surface mounted package; 2 leads

SOD-123

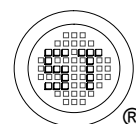
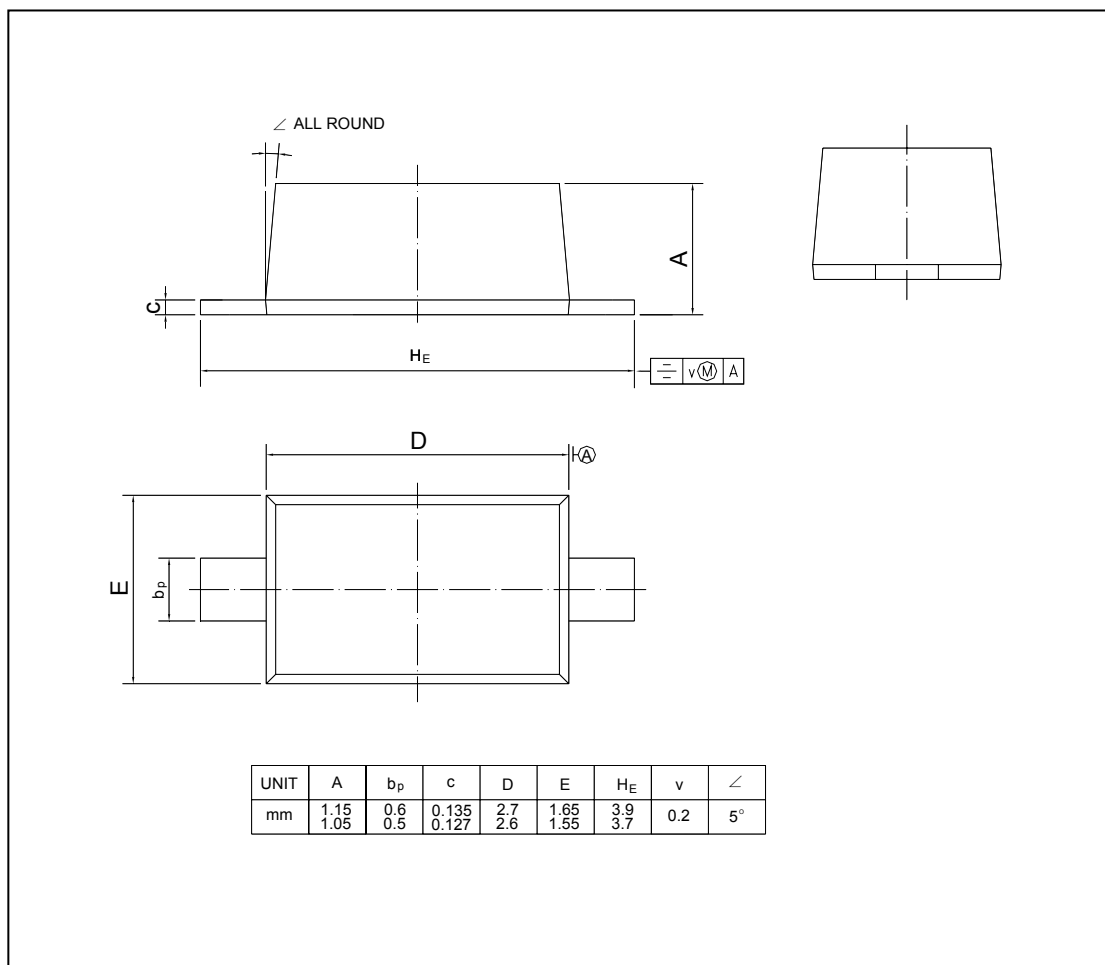

Dated : 26/01/2007